

Strong textile slings that avoid damaging loads,  
allowing use in a wide variety of working environments

# ***KITO TEXTILE SLING***

***KITO POLYESTER SLING***

***KITO CLEAN ROOM SPECIFICATIONS***

All products in this catalog are designed for use in Japan and their labels are also written in Japanese.

In case they are used outside Japan, their working loads and operating methods should be understood.

If you have any questions, please contact KITO overseas partners.



# Strong slings that are gentle to loads

**Combining a toughness which securely supports loads with a flexibility that avoids damaging them!**

**KITO textile slings are available in a colorful and wide variation**

## Features

### Utilizing the optimum polyester yarn

An ideal polyester yarn is utilized which has outstanding tensile strength, elastic elongation, water resistance and light stability.

\* The core yarn of the RD Series Mega Round Slings utilizes ultra high molecular weight polyethylene. For more details, refer to page 8.

### Gently fits to the shape of loads

Have a special structure that gently fits to the shape of loads to avoid damaging them.

### Lightweight type slings that are easy to work with

These lightweight type slings are easy to handle. Moreover, even when slings are folded they will not retain creases.

### Outstanding durability

The slings utilize polyester yarn which is among the strongest synthetic textiles to realize an outstanding durability through the implementation of meticulous processing.

### Allows selection of the ideal sling type to match your application

A complete lineup of colorful and wide ranging types and sizes are offered which can be selected to match your applications and working conditions.

## Applications









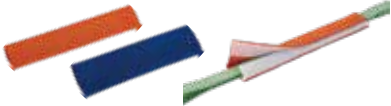

- Wooden products including furniture and musical instruments
- Plated products
- Lead products
- Products with polished finishes such as shafts and rolls
- Light metal products including copper and aluminum
- Stone materials, hume pipes, and concrete products
- Precision machinery
- Paper and paper processing products
- Plastic products
- Rubber products
- Other items that should not be damaged or soiled





ads!

# INDEX | KITO TEXTILE SLING |

Product Features/Applications		P2
BSH Series Belt Slings [0.8t to 12.5t]		P4-5
Protective Corners [Optional]		P6
RE Series Round Slings [1t to 10t]		P7
EE Series Eight-shaped Slings [0.5t to 5t]		P7
REB/EEB/REBC Series Black Polyester Slings [0.5t to 5t]		P8
BCL/BDL Series Endless Belt Slings [0.63t to 10t]		P9
BRL/BTL/BQL Series Other Belt Slings [0.31t to 10t]		P10
BWL Series Slings with Fittings [Small Capacity Types] [250kg (Angle of loading 60°)]		P11
SCL3 Series Slings with Fittings [Standard Specifications] [0.8t to 4.32t]		P12
Way to Read the Ordering Codes (Example)		P12
Standard Specifications: Component Combination Table [Top Fitting + Bottom Fitting]		P13-14
Slinging Methods and Working Load Limits (W.L.L.)	<p>BSH Series Belt Slings RE Series Round Slings, REB Series Black Round Slings EE Series Eight-shaped Slings, EEB Series Black Eight-shaped Slings REBC Series Black Chain-type Slings RD Series Mega Round Slings SCL3 Series Slings with Fittings</p>	P15-16
Special Specification Products		P17
Clean Room Specifications BSH/RE Series [0.8t to 10t]		P18
Safety Precautions/Requests When Ordering Products		P19

# Belt Slings [0.8t to 12.5t]



## Upgraded from JIS Class III to Class IV!

Maximum working load:  
0.8t to 12.5t

# BSH Series

## Belt Slings

JIS B 8818 [JIS Class IV]

[For a belt width of 50mm]  
For the same width of belt as before,

The maximum working load has increased to **125%!**

1.6t → 2.0t

For lifting the same working load weight as before, the belt width has become narrower.

[For a 0.8t W.L.L. sling] From **25mm** to **20mm**

[For a 1.6t W.L.L. sling] From **25mm** to **20mm**

[For a 2.4t W.L.L. sling] From **75mm** to **60mm**

III → IV

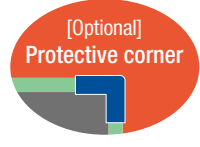
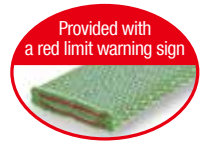
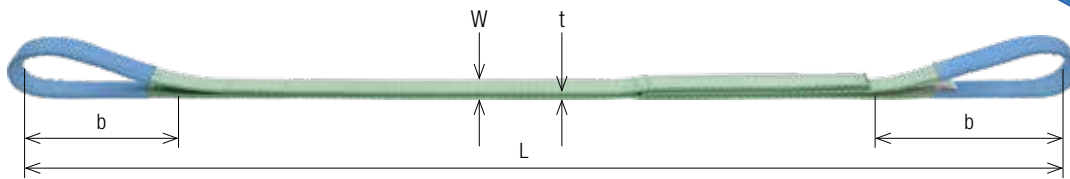

- These are extremely high stability belt slings with suitable widths.
- Because the eye parts at both ends of the sling are tightly bound (depending on the belt size), slinging work is easy. Moreover, since the eye parts are covered with protective fabric, the slings have outstanding durability.
- When the red limit warning sign becomes visible, the sling has reached its usage limit.

JIS label (Type)	Code	Sling width: W (mm)	Maximum working load (t)	Color	Eye length: b (mm)	Belt thickness: t (mm)	Mass (Weight) (kg)		Sling length: L (m)
							Shortest dimension mass (weight)	1m mass (weight)	
SVE-20	BSH008	20	0.8	Light green	200	9	0.30	0.19	Between 1m and 10m in 0.5m intervals
IVE-25	BSH010	25	1				0.30	0.22	
SVE-40	BSH016	40	1.6		0.50		0.32		
IVE-50	BSH020	50	2		0.60		0.41		
SVE-60	BSH024	60	2.4		0.90		0.45	Between 1.5m and 10m in 0.5m intervals	
IVE-75	BSH032	75	3.2		1.10		0.56		
IVE-100	BSH040	100	4		1.60		0.80		
IVE-150	BSH063	150	6.3		2.30		1.20	Between 2m and 10m in 0.5m intervals	
IVE-200	BSH080	200	8		3.70		1.51		
IVE-300	BSH125	300	12.5		5.50		2.21		

- The maximum working loads in the above table indicate the values during straight slinging. For the various slinging methods and the working load limits, refer to page 15.
- Please note that there is a slight variation in dimensions due to the use of fibers. Please consult with us in advance if you need exact length matching such as two-piece sets depending on usage conditions.
- Sling lengths and eye lengths other than those shown in the table above are special specifications.
- JIS is not applicable depending on specifications such as special dimensions, so please consult with us.

**These slings incorporate KITO's original "red limit warning sign", which lets you see at a glance when the usage limit has been reached.**

A red-colored core yarn is interwoven underneath the surface of the belt. When this becomes visible due to wear or damage, the timing for sling replacement can be easily judged. Based on the certain quality fostered by KITO over a period of 30 years, these slings support safe working in all kinds of workplaces, from civil engineering and construction to transportation and shipbuilding.

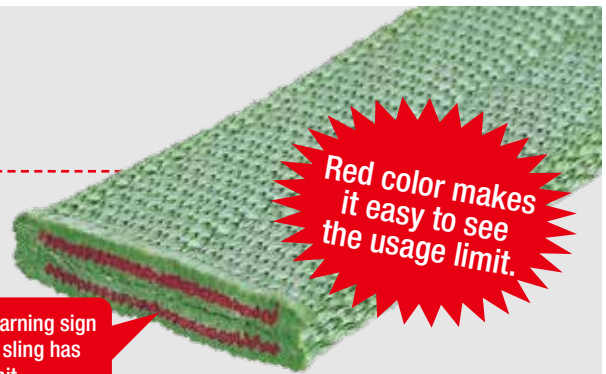

When the red limit warning sign becomes visible, the sling has reached its usage limit.

Due to the red limit warning sign, it is easy to judge when the sling has reached its replacement period even when it has become dirty.



The photographs show KITO belt slings which have actually been used in indoor factories to give an image of the conditions when slings are damaged.

**For loads which have sharp corners, please use protective corners.**

For more details, see page 6.

When using the slings for lifting loads which have sharp corners, be certain to use "protective corners". Note particularly that slings will be damaged if sideways slippage occurs, so try to prevent loads from slipping sideways.

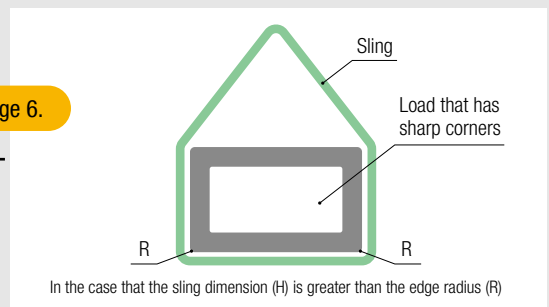

**Special specification products other than those on the left**

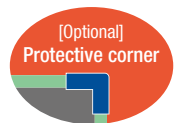
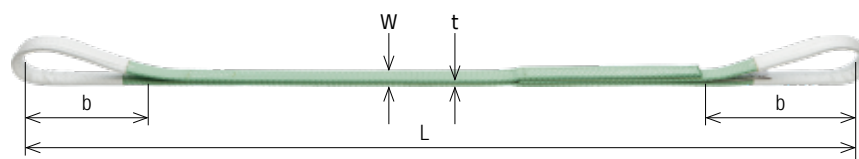

- Special specification products are not JIS applicable. They are not classified as JIS IV. The maximum specification load is shown in the table below.

Code	Sling width: W (mm)	Maximum working load (t)	Color	Eye length: b (mm)	Belt thickness: t (mm)	Shortest sling length: L (m)	Eye part color
Other special shapes	20	0.63	Light green	50 to 200 Less than	9	0.30	White
	25	0.8					
	40	1.25					
	50	1.6					
	60	1.9					
	75	2.5					
	100	3.2					
	150	5.0					
	200	6.3		350 to 550 Less than		1.0	
	300	10.0		550 to 750 Less than		1.45	

- The maximum working loads shown in the table above are for straight suspension. Please refer to the owner's manual for various lifting methods and working loads.
- Please note that there is a slight variation in dimensions due to the use of fibers.

# Protective corners [Optional]

- Protective corners should be used for protecting slings when lifting loads that have sharp corners or which have rough surfaces, and for preventing the sideways slippage of loads.
- Various types and sizes are available, so please select the protective corners in accordance with the sling.

## RC Series Protective Corners [Applicable to BSH/BCL/BRL/RE/EE Series slings]

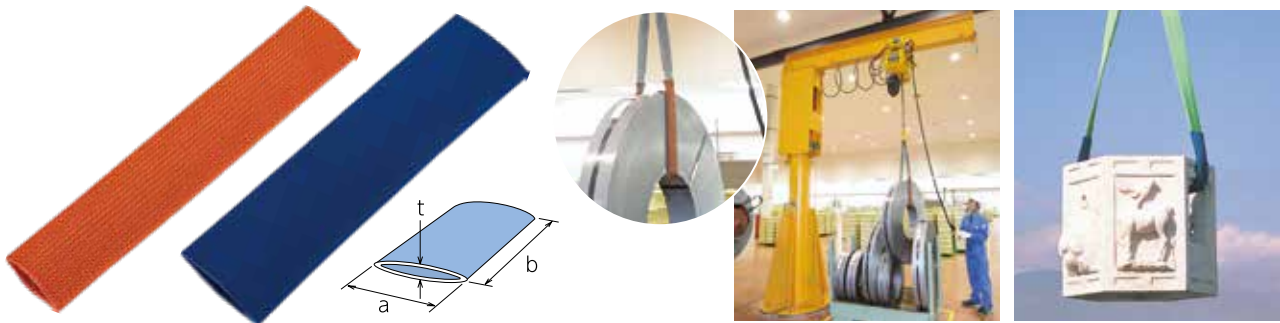

Code	Color	Protective corner dimension (mm)			Applicable sling width (mm)		
		Inner width a	Length b	Thickness t (when there are two layers of material)	BSH,BCL,BRL	RE	EE
RC044	Orange	44	300	5.8	20,25	—	—
RC068		68			40,50	30	—
RC076		76			60	38	65
RC092	Blue	92	400		75	47,52	75
RC160		160			100,150	70	100,125,150
RC220		220			500	200	80

- When using RE Series slings, double slinging is the standard. The RE Series in the above table indicates the case of double sling.
- Requests can also be made for protective corners with special lengths.

## Special Specifications/Product Integration System **Single Corners Sewn onto the Sling** [For RE/BCL/BDL Series slings]

Because the single corners for the RE Series Round Slings and the BCL and BDL Series Endless Slings use a system in which they are integrated into the product (refer to the figure below), please specify the number of corners and order them together with the sling.

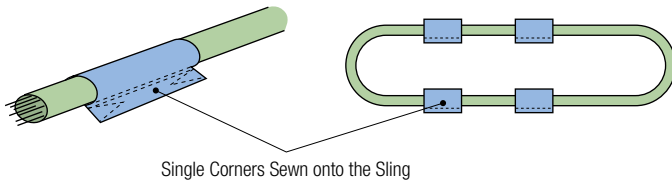

## Special Specifications **MRC Series Protective Corners with Hook & Loop Tape** [Available for each sling width]

These are protective corners which can be easily attached and exchanged simply by wrapping them around the belt and pressing the hook & loop tape together. The corners can also be used for slings with fittings which have the fittings attached to both ends of the belt. The corners come in sizes that can be used with each sling width.

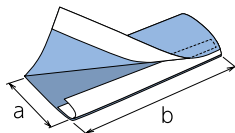

Code	Color	Protective corner dimension (mm)		Applicable sling width (mm)		
		Inner width a	Length b	BSH,BCL,BRL	RE	EE
MRC044	Orange	44	300,500,1000	20,25	—	—
MRC068		68		40,50	30	—
MRC076		76		60	38	65
MRC092	Blue	92	400,1000	75	47,52	75
MRC160		160		100,150	70	100,125,150
MRC220		220		500,1000	200	80

- These corners can also be used with the BDL, BTL, and BQL Series slings. Please contact KITO separately regarding this use.

- The RE Series value in the above table indicates the doubled sling. • Requests can also be made for protective corners with special lengths.

# Round Slings [1t to 10t]

Maximum working load:  
1.0t to 10.0t

## RE Series Round Slings

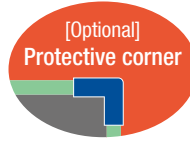
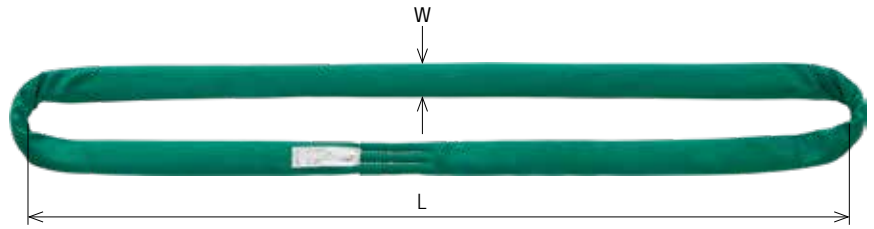

The sling colors allow understanding of the different sling widths and maximum working loads.



- These are endless slings in which strands of strong polyester yarn are bound into a rope form and enclosed in a protective sheet.
- Due to the use of a flexible rope form, the slings are also capable of snugly fitting to a wide variety of load shapes with little slippage to offer outstanding load stability.
- The strength is maintained by the core yarn. If the outer sheath has been damaged and the core yarn becomes visible, the sling has reached its usage limit.

Code	Sling width: W (mm)	Maximum working load (t)	Color	Mass (weight) for each 1m of the dimension L (kg)	Sling length: L (m)
RE010	30	1.0	Purple	0.23	Between 0.5m and 10m in 0.5m intervals
RE020	38	2.0	Green	0.38	
RE032	47	3.2	Yellow	0.57	
RE050	52	5.0	Red	0.99	Between 1m and 10m in 0.5m intervals
RE080	70	8.0	Blue	1.63	Between 2m and 10m in 0.5m intervals
RE100	80	10.0	Orange	2.05	

- The maximum working loads in the above table indicate the values during straight slinging. For the various slinging methods and the working load limits, refer to page 15.
- Regarding requests for sling lengths L (in meters) other than those shown in the above table, please contact KITO separately.
- Note that because textiles are used in these slings, there may be some slight differences in the dimensions.

# Eight-shaped Slings [0.5t to 5t]

Maximum working load:  
0.5t to 5.0t

## EE Series Eight-shaped Slings

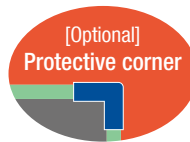
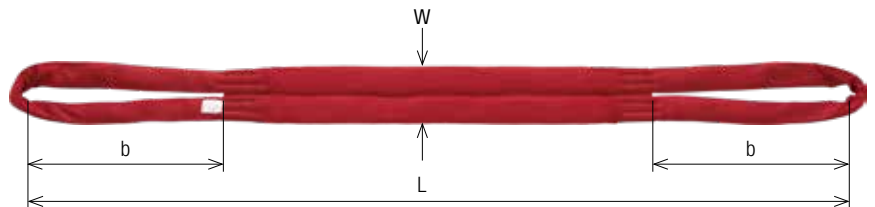

The sling colors allow understanding of the different sling widths and maximum working loads.



- These slings offer outstanding strength and durability using strong polyester as the core yarn.
- Because the body part which bears the weight of the load has a unique double layer structure that is highly flexible, the slings also snugly fit to a wide variety of load shapes.
- The strength is maintained by the core yarn. If the outer sheath has been damaged and the core yarn becomes visible, the sling has reached its usage limit.

Code	Sling width: W (mm)	Maximum working load (t)	Color	Eye length: b (mm)	Mass (Weight) (kg)		Sling length: L (m)
					Shortest dimension mass (weight)	1m mass (weight)	
EE005	65	0.5	Gray	200	0.32	0.20	Between 1.5m and 4m in 0.5m intervals, between 4m and 6m in 1m interval
EE010	75	1.0	Purple	250	0.47	0.30	
EE020	100	2.0	Green	300	0.80	0.45	Between 1.5m and 4m in 0.5m intervals, between 4m and 8m in 1m interval
EE030	125	3.0	Yellow	400	1.11	0.68	Between 2m and 8m in 1m interval
EE050	150	5.0	Red	500	2.38	1.13	

- The maximum working loads in the above table indicate the values during straight slinging. For the various slinging methods and the working load limits, refer to page 15.
- Regarding requests for sling lengths L (in meters) other than those shown in the above table, please contact KITO separately.
- Note that because textiles are used in these slings, there may be some slight differences in the dimensions.

# Black Polyester Slings [0.5t to 5t]

For use at various event spaces such as stages, theaters, halls and studios. The black color of the outer sheath of these textile slings ensures that they do not stand out.

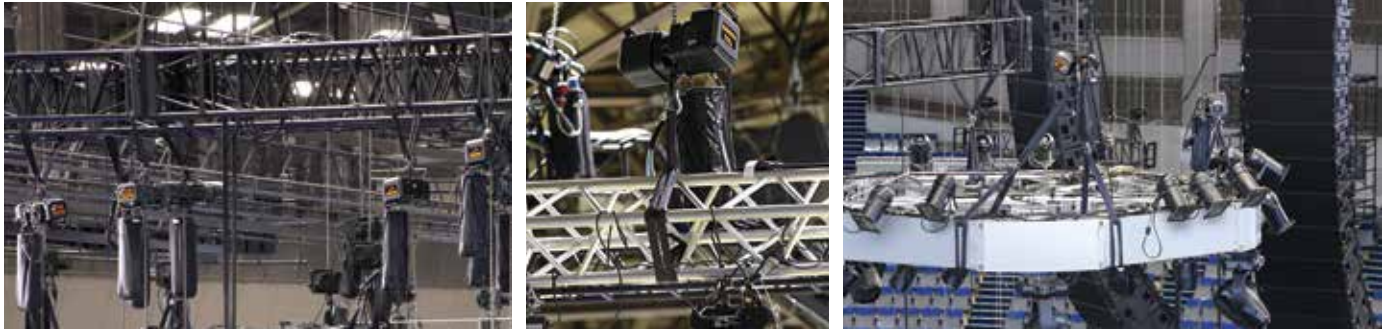

Maximum working load: 1.0t to 5.0t

## REB Series Round Slings

- The sling's outer sheath is an unobtrusive black color.
- These are endless slings in which strong polyester yarn strands are bound into a rope form and enclosed in a protective sheet.
- Due to the use of a flexible rope form, the slings are also capable of snugly fitting to a wide variety of load shapes with little slippage to offer outstanding load stability.
- The strength is maintained by the core yarn. If the outer sheath has been damaged and the core yarn becomes visible, the sling has reached its usage limit.

Code	Sling length: L (m)	Maximum working load (t)	Color	Mass (weight) for each 1m of the dimension L (kg)	Sling length: L (m)
REB 010	30	1.0	Black	0.23	Between 0.5m and 15m in 0.5m intervals
REB 020	38	2.0		0.38	
REB 032	47	3.2		0.57	
REB 050	52	5.0		0.99	Between 1m and 12m in 0.5m intervals

- The maximum working loads in the table at left indicate the values during straight slinging. For the various slinging methods and the working load limits, refer to page 15.
- Regarding requests for sling lengths L (in meters) other than those shown in the table at left, please contact KITO separately.
- Note that because textiles are used, there may be some slight differences in the dimensions.

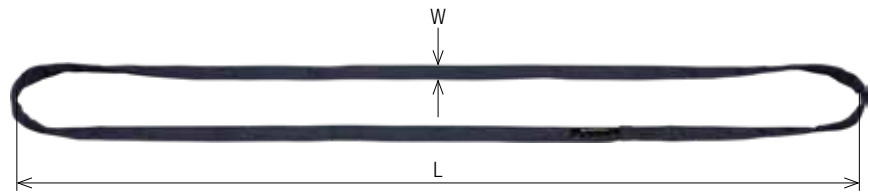

Maximum working load: 1.0t to 5.0t

## EEB Series Eight-shaped Slings

- The sling's outer sheath is an unobtrusive black color.
- These slings offer outstanding strength and durability using strong polyester as the core yarn.
- Because the body part which bears the weight of the load has a unique double layer structure that is highly flexible, the slings also snugly fit to a wide variety of load shapes.
- The strength is maintained by the core yarn. If the outer sheath has been damaged and the core yarn becomes visible, the sling has reached its usage limit.

Code	Sling length: L (m)	Maximum working load (t)	Color	Mass (weight) for each 1m of the dimension L (kg)	Sling length: L (m)
EEB 010	75	1.0	Black	250	Between 1.5m and 11.5m in 0.5m intervals
EEB 020	100	2.0		300	
EEB 030	125	3.2		400	
EEB 050	150	5.0		500	Between 2m and 12m in 1m interval

- The maximum working loads in the table at left indicate the values during straight slinging. For the various slinging methods and the working load limits, refer to page 15.
- Regarding requests for sling lengths L (in meters) other than those shown in the table at left, please contact KITO separately.
- Note that because textiles are used, there may be some slight differences in the dimensions.

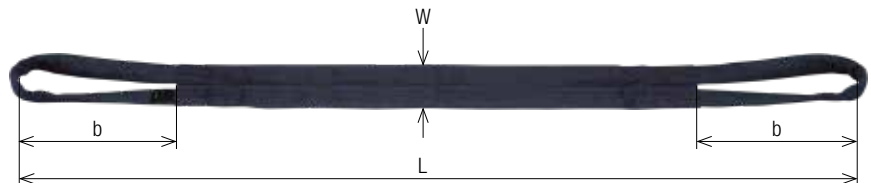

Maximum working load: 0.5t to 2.0t

## REBC Series Chain-type Slings

- The sling's outer sheath is an unobtrusive black color.
- These slings demonstrate their power when establishing various temporary facilities by allowing the hooks of equipment such as motors to be attached in optional positions at intervals of 0.3m or 0.4m.
- This is a new type of polyester sling in which strong polyester yarn strands are bound into rope form, enclosed with a protective sheet, and linked in a chain form.
- The strength is maintained by the core yarn. If the outer sheath has been damaged and the core yarn becomes visible, the sling has reached its usage limit.

Code	Sling length: L (m)	Maximum working load (t)	Color	Ring pitch P (m)	Sling length: L (m)
REBC 005	30	0.5	Black	0.3	0.3m x the number of links
REBC 010	38	1.0			
REBC 015	47	1.5		0.4	0.4m x the number of links
REBC 020	52	2.0			

- The maximum working loads in the table at left indicate the values during straight slinging. For the various slinging methods and the working load limits, refer to page 15.
- As a characteristic of this product, because the manufactured length of each link will slightly differ, please confirm with KITO regarding the detailed dimensions.

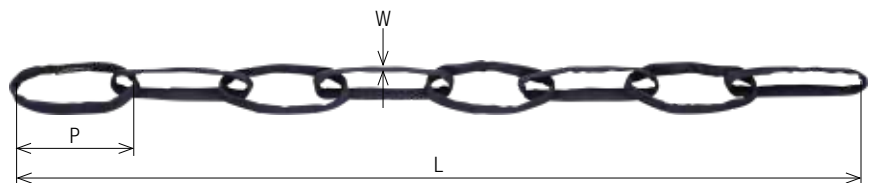



# Endless Belt Slings [0.63t to 10t]

Maximum working load:  
0.63t to 5.0t

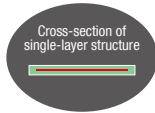

## BCL Series

### Endless Slings

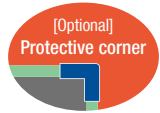
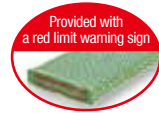
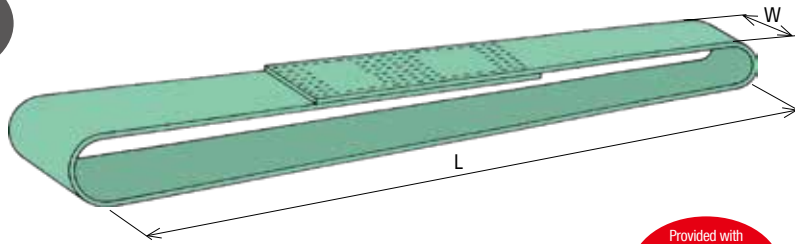

- These endless slings can be used for a variety of slinging methods.
- For the detailed specifications, please contact KITO each time.

Code	Sling width: W (mm)	Maximum working load (t)	Color	Sling length: L (m)
BCL006	20	0.63		
BCL008	25	0.8		
BCL013	40	1.25		
BCL016	50	1.6		
BCL019	60	1.9	Light green	Between 1m and 5m in 0.5m intervals
BCL025	75	2.5		
BCL032	100	3.2		
BCL050	150	5.0		

- The maximum working loads in the above table indicate the values during straight slinging. For the various slinging methods and the working load limits, refer to the Owner's Manual.
- Regarding requests for sling lengths L (in meters) other than those shown in the above table, please contact KITO separately.
- Note that because textiles are used in these slings, there may be some slight differences in the dimensions.

Maximum working load:  
1.25t to 10t

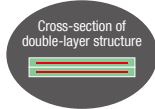

## BDL Series

### Endless Slings

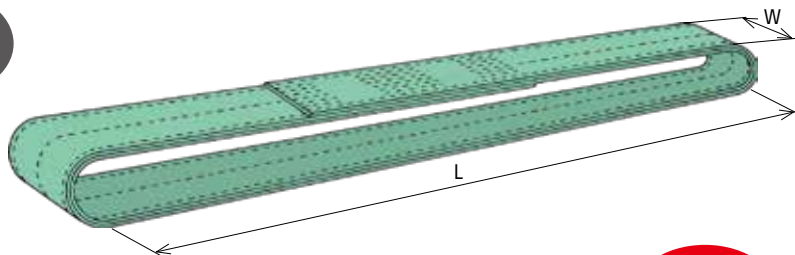

Protective corners with hook & loop tape should be used. Please contact KITO separately.

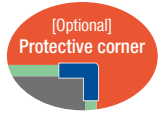
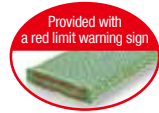

- These endless slings can be used for a variety of slinging methods.
- For the detailed specifications, please contact KITO each time.

Code	Sling width: W (mm)	Maximum working load (t)	Color	Sling length: L (m)
BDL013	20	1.25		
BDL016	25	1.6		
BDL025	40	2.5		
BDL032	50	3.2		
BDL038	60	3.8	Light green	Between 1m and 5m in 0.5m intervals
BDL050	75	5.0		
BDL063	100	6.3		
BDL100	150	10.0		

- The maximum working loads in the above table indicate the values during straight slinging. For the various slinging methods and the working load limits, refer to the Owner's Manual.
- Regarding requests for sling lengths L (in meters) other than those shown in the above table, please contact KITO separately.
- Note that because textiles are used in these slings, there may be some slight differences in the dimensions.

# Other Belt Slings [0.31t to 10t]

Maximum working load:  
0.31t to 2.5t

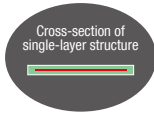

## BRL Series Single-layer Belt Type

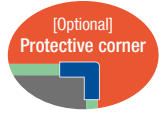
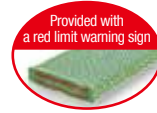
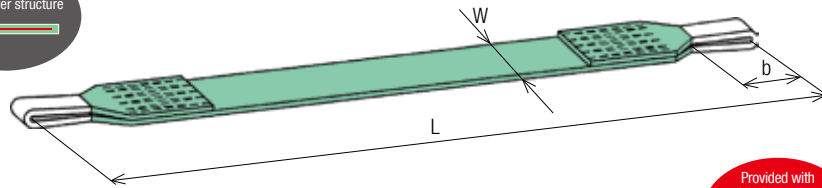

• For the detailed specifications, please contact KITO each time.

Code	Sling width: W (mm)	Maximum working load (t)	Color	Eye length: b (mm)	Sling length: L (m)
BRL003	20	0.31	Light green	200	Between 1m and 5m in 0.5m intervals
BRL004	25	0.4			
BRL006	40	0.63			
BRL008	50	0.8		250	
BRL010	60	0.95			
BRL013	75	1.25			
BRL016	100	1.6	350	Between 1.5m and 5m in 0.5m intervals	
BRL025	150	2.5			400

- The maximum working loads in the table at left indicate the values during straight slinging. For the various slinging methods and working load limits, refer to Owner's Manual.
- Regarding requests for sling lengths L (in meters) other than those shown in the table at left, please contact KITO separately.
- Note that because textiles are used in these slings, there may be some slight differences in the dimensions.
- Cloth of the eye part (white part) is made of nylon.

Maximum working load:  
0.95t to 7.5t

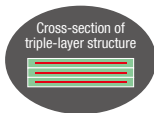

## BTL Series Triple-layer Belt Type

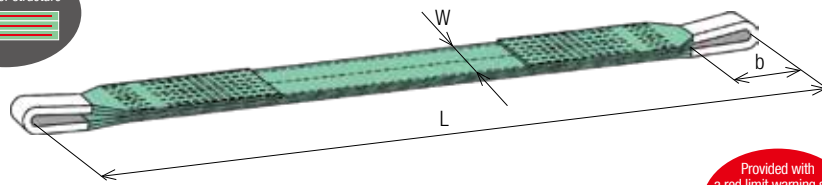

Protective corners with hook & loop tape should be used. Please contact KITO separately.

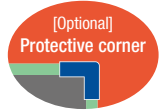
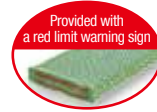

• For the detailed specifications, please contact KITO each time.

Code	Sling width: W (mm)	Maximum working load (t)	Color	Eye length: b (mm)	Sling length: L (m)
BTL010	20	0.95	Light green	200	Between 1m and 5m in 0.5m intervals
BTL012	25	1.2		250	
BTL019	40	1.9		350	
BTL024	50	2.4		400	Between 1.5m and 5m in 0.5m intervals
BTL028	60	2.8			
BTL038	75	3.8			
BTL048	100	4.8		550	Between 2m and 5m in 0.5m intervals
BTL075	150	7.5			

- The maximum working loads in the table at left indicate the values during straight slinging. For the various slinging methods and working load limits, refer to Owner's Manual.
- Regarding requests for sling lengths L (in meters) other than those shown in the table at left, please contact KITO separately.
- Note that because textiles are used in these slings, there may be some slight differences in the dimensions.
- Cloth of the eye part (white part) is made of nylon.

Maximum working load:  
1.25t to 10t

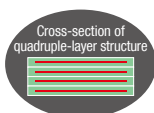

## BQL Series Quadruple-layer Belt Type

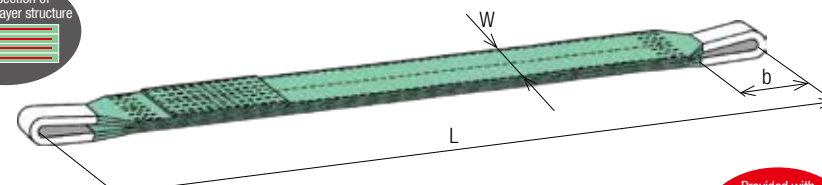

Protective corners with hook & loop tape should be used. Please contact KITO separately.

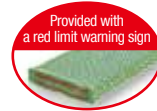

• For the detailed specifications, please contact KITO each time.

Code	Sling width: W (mm)	Maximum working load (t)	Color	Eye length: b (mm)	Sling length: L (m)
BQL013	20	1.25	Light green	200	Between 1m and 5m in 0.5m intervals
BQL016	25	1.6		250	
BQL025	40	2.5		350	
BQL032	50	3.2		400	Between 1.5m and 5m in 0.5m intervals
BQL038	60	3.8			
BQL050	75	5.0			
BQL063	100	6.3		550	Between 2m and 5m in 0.5m intervals
BQL100	150	10.0			

- The maximum working loads in the table at left indicate the values during straight slinging. For the various slinging methods and working load limits, refer to Owner's Manual.
- Regarding requests for sling lengths L (in meters) other than those shown in the table at left, please contact KITO separately.
- Note that because textiles are used in these slings, there may be some slight differences in the dimensions.
- Cloth of the eye part (white part) is made of nylon.

# Slings with Fittings [Small Capacity Types] [250kg (Angle of loading 60°)]

Maximum working load:  
250kg (Angle of loading 60°)

## BWL Series Eight-shaped Slings

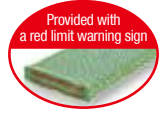

- There are three types of belt end specifications, those with hooks A, with hooks for wooden boxes, and with hooks for containers.
- When the red limit warning sign becomes visible, the sling has reached its usage limit.

These slings are optimal for combining with small capacity 250kg hoists such as the KITO EQ Series Electric Chain Hoists and ED Series Electric Chain Hoists.



Code	Sling width: W (mm)	Maximum working load (t)	Color	Sling length: L (m)	Dimension (mm)					
					p	m	n	s	t	u
BWL-A 002					70	23		24	9	18
BWL-B 002	20	250	Light green	0.4m, 0.6m, 0.8m, 1.0m	50	12	20	27		96
BWL-C 002						19.5	21	25	4.5	90

- The maximum working loads in the above table indicate the case of angle of loading 60°
- Regarding requests for sling lengths L (in meters) other than those shown in the above table, please contact KITO separately.
- Note that because textiles are used in these slings, there may be some slight differences in the dimensions.
- Cloth of the eye part (white part) is made of nylon.

# Slings with Fittings [Standard Specifications]

Maximum working load:  
0.8t to 4.32t

## SCL3 Series Slings with Fittings

The combination of fittings and belts is flexible!  
Best matching between belt slings and the KITO Chain Sling 100 (Eye Type) fittings components.

In the standard specification, the HTL4 fitting is equipped as the bottom fitting.

- By using together with Master Links, slings can be used for a variety of applications such as by looping several belts onto a single lifting hook.
- When the red limit warning sign becomes visible, the sling has reached its usage limit.

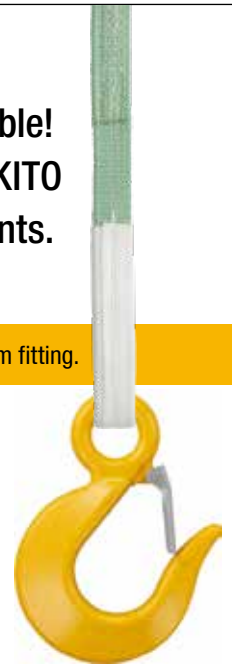
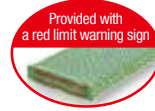

### [Standard specification]

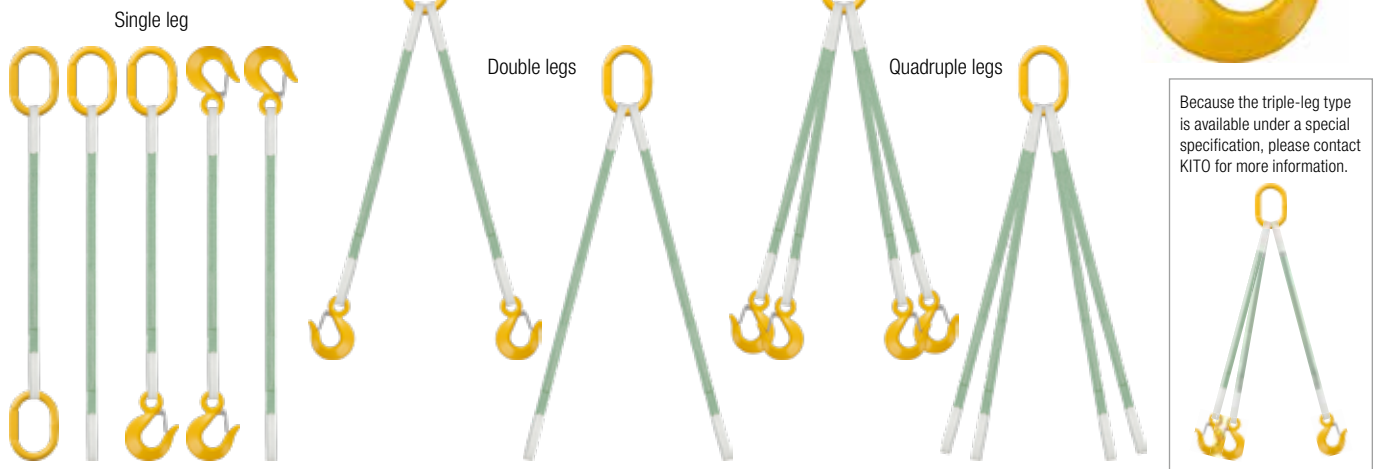

### [Special specification]

The bottom fitting can be changed to match the required application.

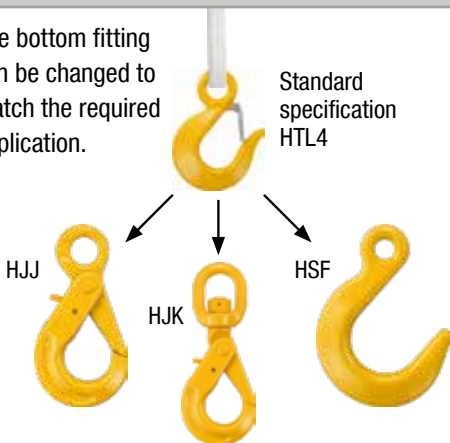

The double-leg, triple-leg and quadruple-leg types can have different lengths for each of the belts.

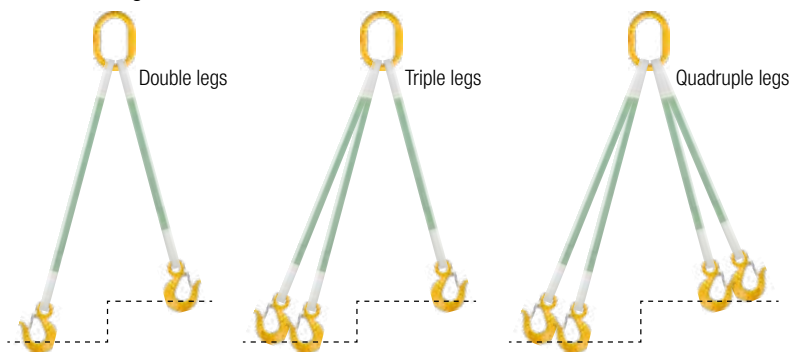

### Way to Read the Ordering Codes (Example)

[Standard specification]  
Used component combination table (P13-P14)

Ordering Code **1** + Ordering Code **2** + **3** Maximum working load

**PS - HMM HTL4 - 040 - 008 1.1t**

Single leg | Top hook | Bottom hook | Belt width | Standard sling length L | Maximum working load (t)





Combined Use Components

When placing orders, be certain to state the maximum working loads.

# Standard Specifications: Used Component Combination Table [Top Fitting + Bottom Fitting] **Single-leg Type**

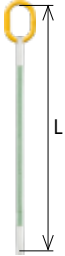
For the way to read the ordering codes, see page 12.

↓ When placing orders, add the **Maximum Working Load** after Code **2**.

Type	Ordering Code <b>1</b>	When placing orders, add Code <b>2</b> to Code <b>1</b> [Order example] When the sling length is 0.6m, add <b>006</b> When the sling length is 1.5m, add <b>015</b>	Maximum working load (t)	Belt width (mm)	Combined use components		Standard sling length: L (m)				
					Top fitting	Bottom fitting	Ordering Code <b>2</b>				
							006	008	010	015	020
	PS-HMMHMM-025- <input type="text"/>	<input type="text"/>	0.8	25	HMM0706	HMM0706	●		●	●	●
	PS-HMMHMM-040- <input type="text"/>	<input type="text"/>	1.25	40	HMM0706	HMM0706		●	●	●	●
	PS-HMMHMM-050- <input type="text"/>	<input type="text"/>	1.6	50	HMM0807	HMM0807		●	●	●	●
	PS-HMMHMM-060- <input type="text"/>	<input type="text"/>	1.9	60	HMM0807	HMM0807			●	●	●
	PS-HMMHMM-075- <input type="text"/>	<input type="text"/>	2.5	75	HMM1008	HMM1008			●	●	●
	PS-HMMHMM-100- <input type="text"/>	<input type="text"/>	3.2	100	HMM1008	HMM1008				●	●
	PS-HMGHMG-050- <input type="text"/>	<input type="text"/>	1.6	50	HMG0807	HMG0807			●	●	●
	PS-HMGHMG-060- <input type="text"/>	<input type="text"/>	1.9	60	HMG0807	HMG0807				●	●
	PS-HMGHMG-075- <input type="text"/>	<input type="text"/>	2.5	75	HMG1008	HMG1008				●	●
	PS-HMGHMG-100- <input type="text"/>	<input type="text"/>	3.2	100	HMG1008	HMG1008				●	●
	PS-HMMET-025- <input type="text"/>	<input type="text"/>	0.8	25	HMM0706	—	●		●	●	●
	PS-HMMET-040- <input type="text"/>	<input type="text"/>	1.25	40	HMM0706	—		●	●	●	●
	PS-HMMET-050- <input type="text"/>	<input type="text"/>	1.6	50	HMM0807	—		●	●	●	●
	PS-HMMET-060- <input type="text"/>	<input type="text"/>	1.9	60	HMM0807	—			●	●	●
	PS-HMMET-075- <input type="text"/>	<input type="text"/>	2.5	75	HMM1008	—			●	●	●
	PS-HMMET-100- <input type="text"/>	<input type="text"/>	3.2	100	HMM1008	—			●	●	●
	PS-HMGET-050- <input type="text"/>	<input type="text"/>	1.6	50	HMG0807	—			●	●	●
	PS-HMGET-060- <input type="text"/>	<input type="text"/>	1.9	60	HMG0807	—			●	●	●
	PS-HMGET-075- <input type="text"/>	<input type="text"/>	2.5	75	HMG1008	—			●	●	●
	PS-HMGET-100- <input type="text"/>	<input type="text"/>	3.2	100	HMG1008	—				●	●
	PS-HMMHTL4-025- <input type="text"/>	<input type="text"/>	0.8	25	HMM0706	HTL4060	●		●	●	●
	PS-HMMHTL4-040- <input type="text"/>	<input type="text"/>	1.1	40	HMM0706	HTL4060		●	●	●	●
			1.25		HMM0706	HTL4080		●	●	●	●
	PS-HMMHTL4-050- <input type="text"/>	<input type="text"/>	1.6	50	HMM0807	HTL4080		●	●	●	●
	PS-HMMHTL4-060- <input type="text"/>	<input type="text"/>	1.9	60	HMM0807	HTL4100			●	●	●
	PS-HMGHTL4-050- <input type="text"/>	<input type="text"/>	1.6	50	HMG0807	HTL4080			●	●	●
PS-HMGHTL4-060- <input type="text"/>	<input type="text"/>	1.9	60	HMG0807	HTL4100				●	●	
	PS-HTL4HTL4-020- <input type="text"/>	<input type="text"/>	0.63	20	HTL4060	HTL4060	●		●	●	●
	PS-HTL4HTL4-025- <input type="text"/>	<input type="text"/>	0.8	25	HTL4060	HTL4060	●		●	●	●
	PS-HTL4HTL4-040- <input type="text"/>	<input type="text"/>	1.1	40	HTL4060	HTL4060		●	●	●	●
			1.25		HTL4080	HTL4080		●	●	●	●
	PS-HTL4HTL4-050- <input type="text"/>	<input type="text"/>	1.6	50	HTL4080	HTL4080		●	●	●	●
	PS-HTL4HTL4-060- <input type="text"/>	<input type="text"/>	1.9	60	HTL4100	HTL4100			●	●	●
	PS-HTL4ET-020- <input type="text"/>	<input type="text"/>	0.63	20	HTL4060	—	●		●	●	●
	PS-HTL4ET-025- <input type="text"/>	<input type="text"/>	0.8	25	HTL4060	—	●		●	●	●
	PS-HTL4ET-040- <input type="text"/>	<input type="text"/>	1.1	40	HTL4060	—		●	●	●	●
			1.25		HTL4080	—		●	●	●	●
	PS-HTL4ET-050- <input type="text"/>	<input type="text"/>	1.6	50	HTL4080	—		●	●	●	●
	PS-HTL4ET-060- <input type="text"/>	<input type="text"/>	1.9	60	HTL4100	—			●	●	●

- Lengths other than those described above can also be ordered. Please contact KITO for more information.
- Regarding the triple-leg type, please contact KITO for more information.
- For detailed specifications, please refer to the KITO CHAIN SLING 100 catalog.
- Cloth of the eye part (white part) is made of nylon.

# Standard Specifications: Used Component Combination Table [Top Fitting + Bottom Fitting] Double-leg Type/Quadruple-leg Type

For the way to read the ordering codes, see page 12.

↓ When placing orders, add the **Maximum Working Load** after Code **2**.

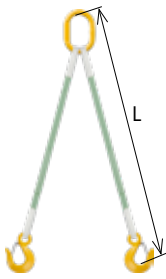
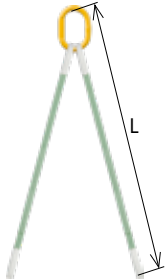
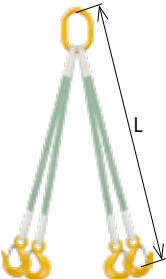
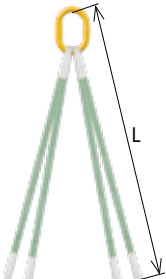
Type	Ordering Code <b>1</b>	When placing orders, add Code <b>2</b> to Code <b>1</b> [Order example] When the sling length is 0.6m, add <b>006</b> When the sling length is 1.5m, add <b>015</b>	Maximum working load (t)	Belt width (mm)	Combined use components		Standard sling length: L (m)				
					Top fitting	Bottom fitting	Ordering Code <b>2</b>				
							006	008	010	015	020
Double legs		PD-HMMHTL4-020- <input type="text"/>	1.13	20	HMM0706	HTL4060	●		●	●	●
		PD-HMMHTL4-025- <input type="text"/>	1.44	25	HMM0807	HTL4060		●	●	●	●
		PD-HMMHTL4-040- <input type="text"/>	1.98	40	HMM1008	HTL4060		●	●	●	●
			2.25		HMM1008	HTL4080		●	●	●	●
		PD-HMMHTL4-050- <input type="text"/>	2.4	50	HMM0807	HTL4080		●	●	●	●
			2.88		HMM1008	HTL4080		●	●	●	●
		PD-HMMHTL4-060- <input type="text"/>	3.2	60	HMM1008	HTL4100			●	●	●
			3.42		HMM1310	HTL4100			●	●	●
		PD-HMGHTL4-020- <input type="text"/>	1.13	20	HMG0807	HTL4060		●	●	●	●
		PD-HMGHTL4-025- <input type="text"/>	1.44	25	HMG0807	HTL4060		●	●	●	●
	PD-HMGHTL4-040- <input type="text"/>	1.98	40	HMG1008	HTL4060			●	●	●	
		2.25		HMG1008	HTL4080			●	●	●	
	PD-HMGHTL4-050- <input type="text"/>	2.88	50	HMG1008	HTL4080			●	●	●	
	PD-HMGHTL4-060- <input type="text"/>	3.2	60	HMG1008	HTL4100				●	●	
		3.42		HMG1310	HTL4100				●	●	
		PD-HMMET-020- <input type="text"/>	1.13	20	HMM0706	—	●		●	●	●
		PD-HMMET-025- <input type="text"/>	1.44	25	HMM0807	—		●	●	●	●
		PD-HMMET-040- <input type="text"/>	2.25	40	HMM1008	—		●	●	●	●
PD-HMMET-050- <input type="text"/>		2.88	50	HMM1008	—		●		●	●	
PD-HMMET-060- <input type="text"/>		3.2	60	HMM1008	—			●	●	●	
		3.42		HMM1310	—			●	●	●	
PD-HMGET-020- <input type="text"/>		1.13	20	HMG0807	—		●	●	●	●	
PD-HMGET-025- <input type="text"/>		1.44	25	HMG0807	—		●	●	●	●	
PD-HMGET-040- <input type="text"/>		2.0	40	HMG0807	—			●	●	●	
		2.25		HMG1008	—			●	●	●	
PD-HMGET-050- <input type="text"/>	2.88	50	HMG1008	—			●	●	●		
PD-HMGET-060- <input type="text"/>	3.2	60	HMG1008	—			●	●	●		
	3.42		HMG1310	—			●	●	●		
Quadruple legs		PQ-HMMHTL4-020- <input type="text"/>	1.7	20	HMM0807	HTL4060		●	●	●	●
		PQ-HMMHTL4-025- <input type="text"/>	2.16	25	HMM1008	HTL4060		●	●	●	●
		PQ-HMGHTL4-020- <input type="text"/>	1.7	20	HMG0807	HTL4060		●	●	●	●
			2.0		HMG0807	HTL4060		●	●	●	●
		PQ-HMGHTL4-025- <input type="text"/>	2.16	25	HMG1008	HTL4060		●	●	●	●
			2.97		HMG1310	HTL4060			●	●	●
	PQ-HMGHTL4-040- <input type="text"/>	3.37	40	HMG1310	HTL4080			●	●	●	
		3.2		HMG1008	HTL4080			●	●	●	
	PQ-HMGHTL4-050- <input type="text"/>	4.32	50	HMG1310	HTL4080			●	●	●	
		PQ-HMMET-020- <input type="text"/>	1.7	20	HMM0807	—		●	●	●	●
		PQ-HMMET-025- <input type="text"/>	2.16	25	HMM1008	—		●	●	●	●
		PQ-HMGET-020- <input type="text"/>	1.7	20	HMG0807	—		●	●	●	●
2.0			HMG0807		—		●	●	●	●	
PQ-HMGET-025- <input type="text"/>		2.16	25	HMG1008	—		●	●	●	●	
		3.2		HMG1008	—			●	●	●	
PQ-HMGET-040- <input type="text"/>	3.37	40	HMG1310	—			●	●	●		
PQ-HMGET-050- <input type="text"/>	4.32	50	HMG1310	—			●	●	●		

- Lengths other than those described above can also be ordered. Please contact KITO for more information.
- Regarding the triple-leg type, please contact KITO for more information.
- For detailed specifications, please refer to the KITO CHAIN SLING 100 catalog.
- Cloth of the eye part (white part) is made of nylon.

# Slinging Methods and Working Load Limits (W.L.L.)

- The maximum working loads shown are the working loads for straight slinging.
- Depending on the load slinging method, the working load limits will change as described in the table below.
- When the edges of the load are not sufficiently round, the values in the following table will be reduced.
- The usage temperature is between -30°C and 50°C. In the case of using slings at temperatures between 50°C and 100°C, use the slings at working loads which are around 50% of the working load limits.

## BSH Series Belt Slings [0.8t to 12.5t]

## RE Series Round Slings [1t to 10t]/ EE Series Eight-shaped Slings [0.5t to 5t]

## REB Series Black Round Slings [1t to 10t]/ EEB Series Black Eight-shaped Slings [0.5t to 5t]/

## REBC Series Black Chain-type Slings [0.5t to 2t]

Unit: ton or less

JIS label (Type)	Code	Sling width (mm)	Slinging method/Angle of loading $\alpha$									
			Straight	Choked					Basket			
				—	$\alpha=0^\circ$	$0^\circ<\alpha\leq 45^\circ$	$45^\circ<\alpha\leq 90^\circ$	$90^\circ<\alpha\leq 120^\circ$	$\alpha=0^\circ$	$0^\circ<\alpha\leq 45^\circ$	$45^\circ<\alpha\leq 90^\circ$	$90^\circ<\alpha\leq 120^\circ$
SIVE-20	BSH008	20	0.8	0.64	1.28	1.12	0.88	0.64	1.6	1.44	1.12	0.8
IVE-25	BSH010	25	1	0.8	1.6	1.4	1.1	0.8	2	1.8	1.4	1
SIVE-40	BSH016	40	1.6	1.28	2.56	2.24	1.76	1.28	3.2	2.88	2.24	1.6
IVE-50	BSH020	50	2	1.6	3.2	2.8	2.2	1.6	4	3.6	2.8	2
SIVE-60	BSH024	60	2.4	1.92	3.84	3.36	2.64	1.92	4.8	4.32	3.36	2.4
IVE-75	BSH032	75	3.2	2.56	5.12	4.48	3.52	2.56	6.4	5.76	4.48	3.2
IVE-100	BSH040	100	4	3.2	6.4	5.6	4.4	3.2	8	7.2	5.6	4
IVE-150	BSH063	150	6.3	5	10	8.82	6.93	5	12.6	11.3	8.82	6.3
IVE-200	BSH080	200	8	6.4	12.8	11.2	8.8	6.4	16	14.4	11.2	8
IVE-300	BSH125	300	12.5	10	20	17.5	13.8	10	25	22.5	17.5	12.5
—	RE010/REB010	30	1.0	0.8	1.6	1.4	1.1	0.8	2.0	1.8	1.4	1.0
	RE020/REB020	38	2.0	1.6	3.2	2.8	2.2	1.6	4.0	3.6	2.8	2.0
	RE032/REB032	47	3.2	2.56	5.12	4.48	3.52	2.56	6.4	5.76	4.48	3.2
	RE050/REB050	52	5.0	4.0	8.0	7.0	5.5	4.0	10.0	9.0	7.0	5.0
	RE080	70	8.0	6.4	12.8	11.2	8.8	6.4	16.0	14.4	11.2	8.0
	RE100	80	10.0	8.0	16.0	14.0	11.0	8.0	20.0	18.0	14.0	10.0
—	EE005	65	0.5	0.4	0.8	0.7	0.55	0.4	1.0	0.9	0.7	0.5
	EE010/EEB010	75	1.0	0.8	1.6	1.4	1.1	0.8	2.0	1.8	1.4	1.0
	EE020/EEB020	100	2.0	1.6	3.2	2.8	2.2	1.6	4.0	3.6	2.8	2.0
	EE030/EEB030	125	3.0	2.4	4.8	4.2	3.3	2.4	6.0	5.4	4.2	3.0
	EE050/EEB050	150	5.0	4.0	8.0	7.0	5.5	4.0	10.0	9.0	7.0	5.0
—	REBC005	30	0.5	0.4	0.8	0.7	0.55	0.4	1.0	0.9	0.7	0.5
	REBC010	38	1.0	0.8	1.6	1.4	1.1	0.8	2.0	1.8	1.4	1.0
	REBC015	47	1.5	1.2	2.4	2.1	1.65	1.2	3.0	2.7	2.1	1.5
	REBC020	52	2.0	1.6	3.2	2.8	2.2	1.6	4.0	3.6	2.8	2.0



\*1: This shows the working load when the load weight has been equally applied to the two legs.

# Slinging Methods and Working Load Limits (W.L.L.)

- The maximum working loads shown are the working loads for straight slinging.
- Depending on the load slinging method, the working load limits will change as described in the table below.
- When the edges of the load are not sufficiently round, the values in the following table will be reduced.
- The usage temperature is between -30°C and 50°C. In the case of using slings at temperatures between 50°C and 100°C, use the slings at working loads which are around 50% of the working load limits.

## Slings with Fittings: Single Leg for the SCL3 (Single-leg Type)

Unit: ton or less

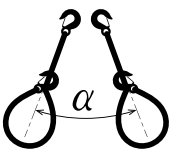
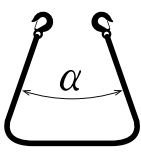
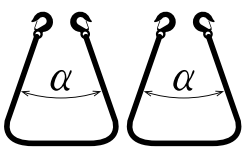
Sling width (mm)	Slinging method/Angle of loading $\alpha$ /Mode factor													
	Straight	Choked					Basket							
		—	$\alpha=0^\circ$	$0^\circ < \alpha \leq 45^\circ$	$45^\circ < \alpha \leq 90^\circ$	$90^\circ < \alpha \leq 120^\circ$	$\alpha=0^\circ$	$0^\circ < \alpha \leq 45^\circ$	$45^\circ < \alpha \leq 90^\circ$	$90^\circ < \alpha \leq 120^\circ$	$\alpha=0^\circ$	$0^\circ < \alpha \leq 45^\circ$	$45^\circ < \alpha \leq 90^\circ$	$90^\circ < \alpha \leq 120^\circ$
	1	0.8	1.6	1.4	1.1	0.8	2	1.8	1.4	1	4	3.6	2.8	2
														
20	0.63	0.5	1.0	0.88	0.69	0.5	1.26	1.13	0.88	0.63	2.52	2.26	1.76	1.26
25	0.8	0.64	1.28	1.12	0.88	0.64	1.6	1.44	1.12	0.8	3.2	2.88	2.24	1.6
40	1.1	0.88	1.76	1.54	1.21	0.88	2.2	1.98	1.54	1.1	4.4	3.96	3.08	2.2
	1.25	1.0	2.0	1.75	1.37	1.0	2.5	2.25	1.75	1.25	5.0	4.5	3.5	2.5
50	1.6	1.28	2.56	2.24	1.76	1.28	3.2	2.88	2.24	1.6	6.4	5.76	4.48	3.2
60	1.9	1.52	3.04	2.66	2.09	1.52	3.8	3.42	2.66	1.9	7.6	6.84	5.32	3.8
75	2.5	2.0	4.0	3.5	2.75	2.0	5.0	4.5	3.5	2.5	10.0	9.0	7.0	5.0
100	3.2	2.56	5.12	4.48	3.52	2.56	6.4	5.76	4.48	3.2	12.8	11.52	8.96	6.4

## Slings with Fittings: Double Legs for the SCL3 (Double-leg Type)

Unit: ton or less

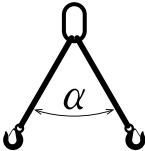
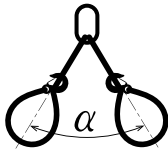
Sling width (mm)	Slinging method/Angle of loading $\alpha$	
	Looped on hook	Choked
	$0^\circ < \alpha \leq 45^\circ$	
		
20	1.13	0.87
25	1.44	1.11
	1.98	1.53
40	2.0	1.55
	2.25	1.74
50	2.0	1.55
	2.4	1.86
60	2.88	2.23
	3.2	2.48
	3.42	2.65

## Sling with Fittings: Triple Legs/Quadruple Legs for the SCL3 (Triple-leg/Quadruple-leg Type)

Unit: ton or less

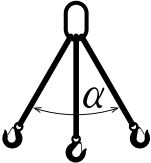
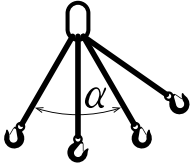
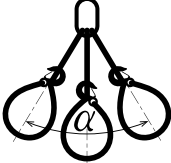
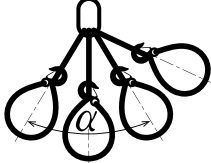
Sling width (mm)	Slinging method/Angle of loading $\alpha$ /Mode factor			
	Looped on hook		Choked	
	$0^\circ < \alpha \leq 45^\circ$			
				
20	1.7	2.0	1.32	1.55
25	2.0	2.16	1.67	1.98
	2.0	2.3	1.55	1.86
40	2.97	3.2	2.48	2.88
	3.2	3.37	2.61	3.08
50	3.2	3.52	2.48	2.88
	4.32	4.32	3.35	3.35



# Special Specification Products

When requesting a quotation, please complete the items in the following table and submit it to your nearest KITO subsidiary or distributor.



<https://www.kito.co.jp/en/company/globalnetwork/>

Company name

Name of contact person

TEL

FAX

E-mail

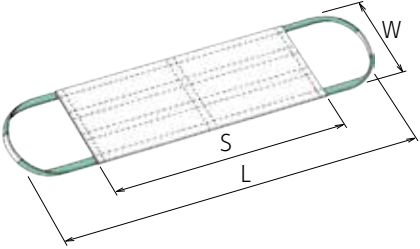
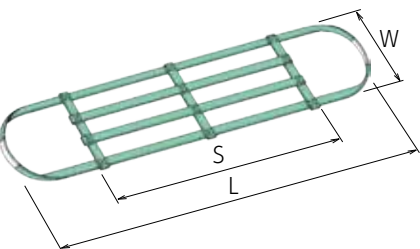
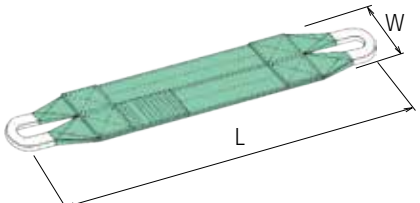
<input type="checkbox"/> <b>Mask-shaped sling</b> Mask-shaped products	<input type="checkbox"/> <b>Lattice-shaped sling</b> Lattice-shaped products	<input type="checkbox"/> <b>F-shaped sling</b> Double-width products
		

## Specifications

Product type	<input type="checkbox"/> Mask-shaped sling	<input type="checkbox"/> Lattice-shaped sling	<input type="checkbox"/> F-shaped sling
Length (S)	[	]	m * Not required for F-shaped slings
Sling length (L)	[	]	m
Width (W)	[	]	mm
Working load limit	[	]	kg

# Clean Room Specifications [0.8t to 10t]

By adopting a cleaning system for clean rooms, KITO's clean room specification polyester slings can be used in clean rooms which have a Class 1000 cleanness rating. After washing and drying, the slings are packaged in dedicated clean bags for delivery.

## Maintaining the product cleanness

### Cleaning system for clean rooms process

Foreign object mixture inspection and damage confirmation



Laundering

Washing in pure water



Natural drying

Particle measurement after drying  
Class M3.5 (Class 100) or less



Deaerated packaging

Use of dedicated clean bags  
Heat seal processing



External appearance and numerical confirmation



Maximum working load:  
BSH Series: 0.8t to 8t

# BSH Series



Clean Room Specification BSH016

Maximum working load:  
1t to 10t

# RE Series



Clean Room Specification RE010



Clean Room Specification RE020



Clean Room Specification RE032

## Safety precautions

### Be careful of the angle of loading

Note that the sling's working load limit will differ depending on the load slinging method used. For the various types of slinging methods and working load limits, refer to pages 15 and 16.



### Use the slings at temperatures between -30°C and 50°C.

In unavoidable situations, the products may be used under conditions with temperatures up to 100°C while referring to the working load limit reductions shown on page 15. For working under high temperatures, you should utilize the KITO Chain Sling 100.



### When the red limit warning sign becomes visible, the sling has reached its usage limit.

#### (Certain product types)

Slings in which the limit warning sign core yarn (red-colored) has become visible due to damage such as fraying have reached their usage limit. Additionally, broken or frayed stitching also indicates that a product has reached its usage limit. (Refer to page 5.)



### Use protective corners when loads have sharp edges

Be certain to use protective corners when lifting loads that have sharp corners or which have rough surfaces. In particular, slings will be damaged if sideways slippage occurs, so care will be required to prevent loads from slipping sideways. (Refer to page 6.)



### Other cautions

- Do not attempt to pull slings out from underneath the load or to drag slings along the ground.
- Before use, be certain to inspect slings to confirm that the core yarn (limit warning sign) is not visible, no damage to stitching, and that stitching is not broken.
- When slings become dirty, wash them in water using a neutral detergent, dry them in a well-ventilated area out of the sun, then store them in a cool, dark location.
- Cannot be used under the conditions of use where it is immersed in or adheres to acids, alkaline chemicals and organic solvents.
- If you intend to use the slings under special conditions, please contact KITO in advance.

## Requests When Ordering Products

Please specify the sling widths, maximum working loads and lengths that match the dead load, size and shape of the load for lifting.

Be sure to specify a length to matches the actual load shape because belt slings which have short sling may have an insufficient lifting allowance.

Note that the lengths of the Round Slings (RE/REB/RD Series) and the Endless Slings (BCL/BDL Series) are given as the folded length.

Standards for disposal of products depending on whether the period of usage is indoors or outdoors (JIS B 8818)

Depending on the belt sling usage conditions, even if there is no damage visible on the appearance and no abnormality, use should be discontinued when the usage period exceeds the following limits.

- When products have been used indoors, seven years after the start of use
- When products have habitually been used outdoors, three years after the start of use

- 
- The products mentioned in this catalog have been designed and manufactured for the purpose of lifting loads.  
Products which use for the purposes other than lifting loads such as incorporating products into customer's facilities and equipment, the performance and functions will not be guaranteed.
  - KITO shall not be liable for any incidental damage due to the use or non-use of the product such as the loss of business profit, suspension of business and damage of the lifted load.
  - KITO shall not be liable for any damage arising from the malfunction due to the combination of the product with other devices in which KITO is not concerned.
  - In case you intend to use our products for special purposes, consult KITO in advance.
  - The products mentioned in this catalog comprise products manufactured in Japan, Germany, and China.
  - In case you intend to export our products, consult KITO in advance. There are different standards and regulations from one destination to another.
  - It is prohibited to reprint, copy or divert all the information in this catalog (trademarks, photos, designs, texts, illustrations, etc.) without our consent.
  - The specifications in this catalog are partly subject to change without prior notice.

---

# KITO

**KITO CORPORATION**

SHINJUKU NS Bldg. 9F, 2-4-1 Nishi-Shinjuku, Shinjuku-ku, Tokyo 163-0809, Japan

TEL: +81-3-5908-0180

[www.kito.co.jp](http://www.kito.co.jp)

Distributed by: